

KEK TECHNICAL DATA SHEET OIL PRESS RANGE



KEK TECHNICAL DETAILS P0020

Screw Press	Type:	P0020
Capacity	appr. lbs/hr:	44
Drive Motor	HP:	3
Net Weight	appr. lbs:	275
Gross Weight	appr. lbs:	348
Crate Volume	appr. cu. ft.:	25
Crate Dimensions	appr. inches W:	47
	appr. inches H:	32
	appr. inches D:	28

DIMENSIONS P0020

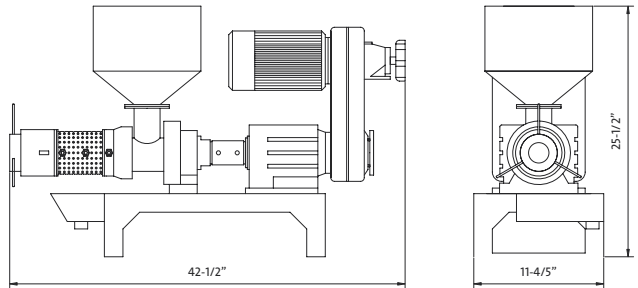

KEK TECHNICAL DETAILS P0101

Screw Press	Type:	P0101
Capacity	appr. lbs/hr:	220
Drive Motor	HP:	10
Net Weight	appr. lbs:	2024
Gross Weight	appr. lbs:	2090
Crate Volume	appr. cu. ft.:	131
Crate Dimensions	appr. inches W:	88
	appr. inches H:	59
	appr. inches D:	44

DIMENSIONS P0101

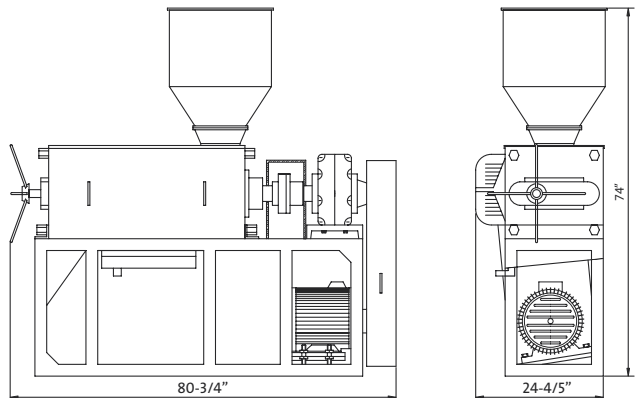

KEK TECHNICAL DATA SHEET OIL PRESS RANGE



KEK TECHNICAL DETAILS P0500

Screw Press	Type:	P0500
Capacity	appr. lbs/hr:	1100
Drive Motor	HP:	30
Net Weight	appr. lbs:	8140
Gross Weight	appr. lbs:	8690
Crate Volume	appr. cu. ft.:	463
Crate Dimensions	appr. inches W:	160
	appr. inches H:	80
	appr. inches D:	63

DIMENSIONS P0500

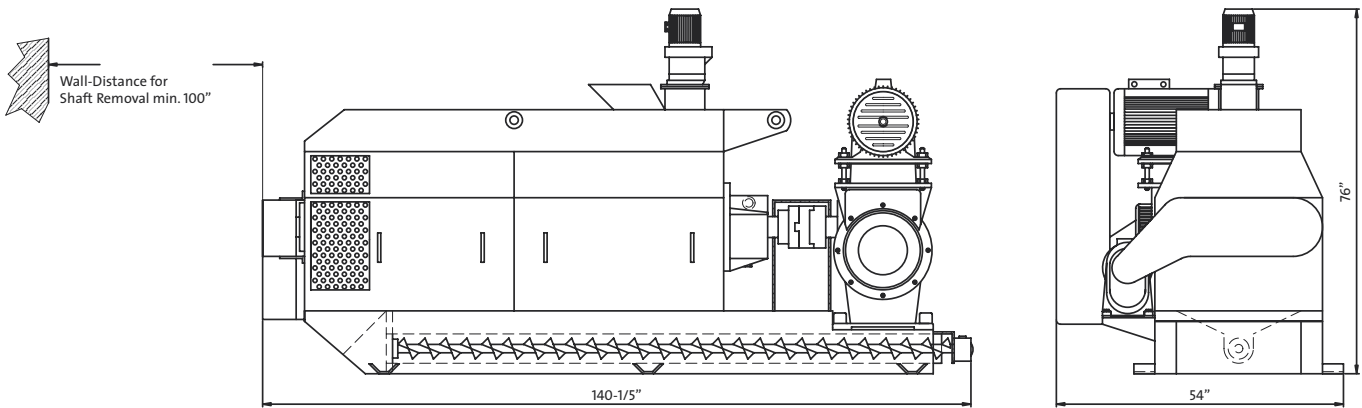

EGON KELLER GMBH & CO. KG

Anton-Küppers-Weg 17
 P.O. Box: 140350
 D-42824 Remscheid
 Germany
 Phone +49-2191-84100
 Fax +49-2191-8628
 Fax +49-2191-8629
 E-Mail info@keller-kek.de
www.keller-kek.de